

2.2V-5.5V Vin, 1A, 8uA Iq, Low-Dropout Regulator

FEATURES

- Qualified for Automotive Applications
- AEC-Q100 Qualified with the Following Results:
 - Device Temperature Grade 1: -40°C to 125°C
- Wide Input Range: 2.2V-5.5V
- Maximum Output Current: 1A
- Adjustable Voltage: 0.8V-5V
- Output Voltage Accuracy:
 - $T_J = 25^\circ\text{C} : \pm 1\%$
 - $T_J = -40^\circ\text{C} \sim 125^\circ\text{C} : \pm 2\%$
- Low Quiescent Current: 8uA
- Ultra-Low Shutdown Current: 0.02uA
- Low Dropout Voltage :
 - 54mV at 200mA load current
 - 143mV at 500mA load current
- Support Output Capacitors Range:
 - 2.2uF~220uF
 - Low-ESR: 0.001Ω~ 5 Ω
- 2.4ms Internal Soft-start Time
- Integrated Short-Circuit Protection with OCFB (Over Current Fold-back) Feature
- Enable pin is available
- Over-Temperature Protection
- Active Output Discharge
- Available Package: TDFN3x3-8

APPLICATIONS

- Battery-Powered Systems
- Automotive infotainment
- Navigation systems
- Portable appliances

DESCRIPTION

The SCT71010A00Q product is a low-dropout linear regulator designed to operate with a wide input-voltage range from 2.2 V to 5.5 V and 1A output current with enable control. The SCT71010A00Q product is stable with 2.2uF~220uF output capacitors, and 10uF ceramic capacitor is recommended.

Only 8-μA typical quiescent current at light load makes the SCT71010A00Q product ideal choices for portable devices with battery power supply and an optimal solution for powering microcontrollers (MCUs) and CAN/LIN transceivers in always-on systems.

The SCT71010A00Q product integrated short-circuit and overcurrent protection with OCFB (Over Current Fold-back) feature, which makes the device more reliable during transient high-load current faults or shorting events.

The SCT71010A00Q series products implements power good circuit (PG) which indicates that output voltage is in regulation. This signal could be used for power sequencing or as a microcontroller reset.

The SCT71010A00Q product could adjust output voltage version with 0.8V feedback voltage and have active output discharge.

The SCT71010A00Q product is available in TDFN3x3-8 packages, for other package options, please contact SCT sales.

TYPICAL APPLICATION

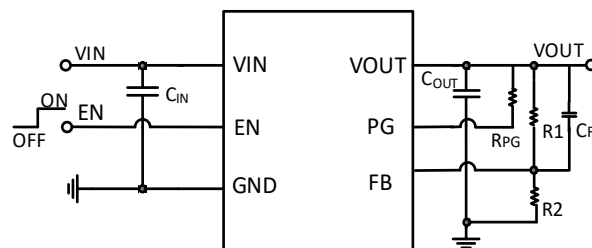

SCT71010A00Q Series

REVISION HISTORY

NOTE: Page numbers for previous revisions may differ from page numbers in the current version.

Revision 1.0: Release to production.

DEVICE ORDER INFORMATION

Orderable Device	Output Voltage	Package	Package Marking	PINS	Transport Media, Quantity
SCT71010A00QDTBR	Adjust	TDFN3x3-8	0A00Q	8	Tape & Reel, 5000

PIN CONFIGURATION

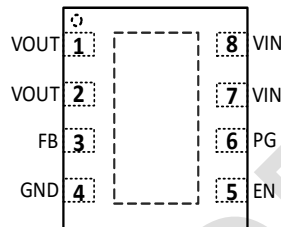

SCT71010A00QDTBR

TDFN3x3-8 Package

PIN FUNCTIONS

TDFN3x3-8/SCT71010A00Q:

NAME	NAME	PIN FUNCTION
1	VOUT	Regulated output voltage pin
2	VOUT	Regulated output voltage pin
3	FB	Feedback voltage pin
4	GND	Ground reference pin.
5	EN	Enable input pin. This pin has an internal resistor($R_{EN_pulldown}$) to hold the regulator off by default. A low voltage($V_{EN} < V_{EN_L}$) on this pin turns the regulator off and discharges the output pin to GND through an internal pulldown resistor($R_{discharge}$).A high voltage($V_{EN} > V_{EN_H}$) on this pin enables the regulator output.The pulldown resistor($R_{EN_pulldown}$). $R_{EN_pulldown}$ is disconnected to reduce input current when $V_{EN} > V_{EN_H}$.
6	PG	Power-good pin
7	VIN	Input voltage pin
8	VIN	Input voltage pin
9	Thermal Pad	Connect the thermal pad to a large area GND plane for improved thermal performance.

RECOMMENDED OPERATING CONDITIONS

Over operating free-air temperature range unless otherwise noted

PARAMETER	DEFINITION	MIN	MAX	UNIT
V _{IN}	Input voltage range	2.2	5.5	V
V _{OUT}	Output voltage range	0.8	5	V
V _{EN}	Enable input voltage	0	V _{IN}	V
C _{IN}	Input capacitor	2.2	--	uF
C _{OUT}	Output capacitor	2.2	220	uF
ESR	Output capacitor ESR requirements	0.001	5	Ω
T _J	Operating junction temperature	-40	125	°C

ABSOLUTE MAXIMUM RATINGS

Over operating free-air temperature range unless otherwise noted ⁽¹⁾

PARAMETER	DEFINITION	MIN	MAX	UNIT
V _{IN}	Maximum input voltage range	-0.3	6	V
V _{OUT}	Maximum output voltage range	-0.3	6	V
V _{EN}	Maximum enable input voltage	-0.3	V _{IN}	V
T _J ⁽²⁾	Junction temperature range	-40	150	°C
T _{stg}	Storage temperature range	-65	150	°C

- (1) Stresses beyond those listed under Absolute Maximum Rating may cause device permanent damage. The device is not guaranteed to function outside of its Recommended Operation Conditions.
- (2) The IC includes over temperature protection to protect the device during overload conditions. Junction temperature will exceed 150°C when over temperature protection is active. Continuous operation above the specified maximum operating junction temperature will reduce lifetime.

ESD RATINGS

PARAMETER	DEFINITION	MIN	MAX	UNIT
V _{ESD}	Human Body Model(HBM), per ANSI-JEDEC-JS-001-2014 specification, all pins ⁽¹⁾	-5	+5	kV
	Charged Device Model(CDM), per ANSI-JEDEC-JS-002-2014 specification, all pins ⁽²⁾	-1	+1	kV

- (1) JEDEC document JEP155 states that 500V HBM allows safe manufacturing with a standard ESD control process.
- (2) JEDEC document JEP157 states that 250V CDM allows safe manufacturing with a standard ESD control process.

SCT71010A00Q Series

THERMAL INFORMATION

The value of $R_{\theta JA}$ and $R_{\theta JC}$ given in this table is only valid for comparison with other packages and cannot be used for design purposes. Because they were simulated in accordance with JESD 51-7. They do not represent the performance obtained in an actual application. For design information see Power Dissipation and Thermal Performance section.

The value of $R_{\theta JA_EVM}$ is the tested results based on our EVM, and is more useful for thermal design. Even if it still do not represent the thermal performance of customer's PCB design, but it was a good starting point for thermal performance design.

The PCB information of our EVM: 4-layer, 1oz Cu (inner 0.5oz Cu), 50mm x 30mm size.

The values given in this table are not a characteristic of package itself, but of many other system level characteristics such as the design and layout of the printed circuit board (PCB), thermal pad size, and external environmental factors. The PCB board is a heat sink that is soldered to the leads and thermal pad of the device. Changing the design or configuration of the PCB board changes the efficiency of the heat sink and therefore the actual values of the below table.

PARAMETER (4-layer)	THERMAL METRIC	TDFN3X3-8	UNIT
$R_{\theta JA}$ ⁽¹⁾	Junction to ambient thermal resistance	78.05	°C/W
Ψ_{JT}	Junction-to-top characterization parameter	19.7	
Ψ_{JB}	Junction-to-board characterization parameter	36.11	
$R_{\theta JCtop}$ ⁽²⁾	Junction to case thermal resistance	100	
$R_{\theta JA_EVM}$ ⁽³⁾	junction to ambient thermal resistance	53.09	

(1) $R_{\theta JA}$ is junction to ambient thermal resistance, based on JESD51-7.

(2) $R_{\theta JC}$ is junction to case thermal resistance, based on JESD51-7.

(3) $R_{\theta JA_EVM}$ is junction to ambient thermal resistance, which is tested on SCT EVM.

ELECTRICAL CHARACTERISTICS

$V_{IN}=V_{OUT}+1V$, $C_{OUT}=10\mu F$, $T_J=-40^{\circ}C\sim 125^{\circ}C$, typical value is tested under $25^{\circ}C$.

SYMBOL	PARAMETER	TEST CONDITION	MIN	TYP	MAX	UNIT
Power Supply						
V_{IN}	Operating input voltage		2.2		5.5	V
V_{UVLO}	V_{IN} UVLO Threshold Hysteresis	V_{IN} rising		2 100	2.195	V mV
I_{SHDN}	Shutdown current from V_{IN} pin	$EN=0$, $2.2V\leq V_{IN}\leq 2.8V$, $T_J=25^{\circ}C$		0.02	0.2	μA
		$EN=0$, $2.2V\leq V_{IN}\leq 2.8V$, $T_J=-40^{\circ}C\sim 125^{\circ}C$			1.2	μA
I_q	Quiescent current from GND pin	EN float, no load, $V_{IN}=V_{OUT}+1V$, $T_J=25^{\circ}C$		8	12	μA
		EN float, no load, $V_{IN}=V_{OUT}+1V$, $T_J=-40^{\circ}C\sim 125^{\circ}C$			16	μA
Regulated Output Voltage and Current						
V_{OUT}	Output voltage accuracy	$I_{OUT}=1mA$, $T_J=25^{\circ}C$	-1%		1%	
		$I_{OUT}=1mA$, $T_J=-40^{\circ}C\sim 125^{\circ}C$	-2%		2%	
V_{REF}	Feedback voltage accuracy	$T_J=25^{\circ}C$	792	800	808	mV
		$T_J=-40^{\circ}C\sim 125^{\circ}C$	784	800	816	mV
ΔV_{OUT}	Line regulation	$V_{IN}=V_{OUT}+1V$ to $5.5V$, $I_{OUT}=1mA$		3	10	mV
	Load regulation	$I_{OUT}=1mA$ to $1A$		10	20	mV
V_{DROP}	Dropout voltage ⁽¹⁾	$V_{IN}=V_{OUT}-0.1V$, $I_{OUT}=100mA$		28		mV
		$V_{IN}=V_{OUT}-0.1V$, $I_{OUT}=200mA$		54		mV
		$V_{IN}=V_{OUT}-0.1V$, $I_{OUT}=500mA$		143		mV
		$V_{IN}=V_{OUT}-0.1V$, $I_{OUT}=1000mA$		297		mV
I_{OUT}	Output current	V_{OUT} in regulation	0		1000	mA
I_{OC}	Output current limit	V_{OUT} short to $90\% \times V_{OUT}$, $T_J=25^{\circ}C$	1250	1500	1850	mA
		V_{OUT} short to $90\% \times V_{OUT}$, $T_J=-40^{\circ}C\sim 125^{\circ}C$	1100		2000	mA
I_{SC}	Short current limit	$V_{OUT}=0V$		510		mA
$PSRR$	Power supply rejection ratio ⁽²⁾	$V_{OUT}=1.2V$, $I_{OUT}=10mA$, $f=1kHz$, $C_{OUT}=10\mu F$		47		dB
		$V_{OUT}=1.2V$, $I_{OUT}=10mA$, $f=10kHz$, $C_{OUT}=10\mu F$		32		dB
		$V_{OUT}=1.2V$, $I_{OUT}=10mA$, $f=100kHz$, $C_{OUT}=10\mu F$		43		dB
Over Voltage Protection						
OVP_H	overshoot of V_{out} when discharge occur	$V_{IN}=3.3V$		115%		
OVP_L	overshoot of V_{out} when discharge disappear	$V_{IN}=3.3V$		110%		
OVP_{Hys}	overshoot of V_{out} hysteresis			5%		
Enable and Soft-startup						
V_{EN_H}	Enable rising threshold	$V_{EN_H_3.3}(V_{IN}=3.3V)$		0.75	0.95	V
		$V_{EN_H_5}(V_{IN}=5V)$		0.867	1	
V_{EN_L}	Enable falling threshold	$V_{EN_L_3.3}(V_{IN}=3.3V)$	0.45	0.66		V
		$V_{EN_L_5}(V_{IN}=5V)$	0.5	0.685		

SCT71010A00Q Series

SYMBOL	PARAMETER	TEST CONDITION	MIN	TYP	MAX	UNIT
V _{EN_Hys}	Enable threshold hysteresis	V _{EN_Hys_3.3} (V _{IN} =3.3V)		85		mV
		V _{EN_Hys_5} (V _{IN} =5V)		180		
I _{EN_0V}	Enable pin current	EN=0			0.2	μA
I _{EN_3.3V}	Enable pin current	EN=3.3V		0.01	0.2	μA
R _{EN_pulldown}	enable pulldown resistor			648		kΩ
T _{SS}	Soft-start time			2.4		ms
Power Good						
V _{PG_R}	PG rising threshold percentage	V _{OUT} /V _{OUT(NOM)} , when V _{OUT} rising		88%		
V _{PG_F}	PG falling threshold percentage	V _{OUT} /V _{OUT(NOM)} , when V _{OUT} falling		82%		
V _{PG_LOW}	PG output low voltage	PG sink 0.5mA		84		mV
R _{PG}	PG pull down resistor	R _{PG} =V _{PG_LOW} /0.5mA		168		Ω
I _{PG_LKG}	PG leakage current	PG=5V, V _{OUT} in regulation			0.2	uA
T _{d_PGR}	PG signal turn to high delay	From V _{OUT} >0.88xV _{OUT(NOM)} to PG rising edge delay time		170		us
T _{d_PGF}	PG signal turn to low delay	From V _{OUT} <0.82xV _{OUT(NOM)} to PG falling edge delay time		88		us
Active Discharge						
R _{discharge}	Low output NMOS on resistance	EN=0, V _{IN} =3.3V		133		Ω
Thermal Protection						
T _{SD}	Thermal shutdown threshold ⁽³⁾	T _J rising		170		°C
		Hysteresis		15		°C

(1) The dropout voltage is defined as V_{IN}-V_{OUT}, when force V_{IN} is 100mV below the value of V_{OUT} for V_{IN}=V_{OUT(NOM)}+1V.

(2) PSRR is derived from bench characterization, not production test.

(3) Thermal shutdown threshold is derived from bench characterization, not production test.

TYPICAL CHARACTERISTICS

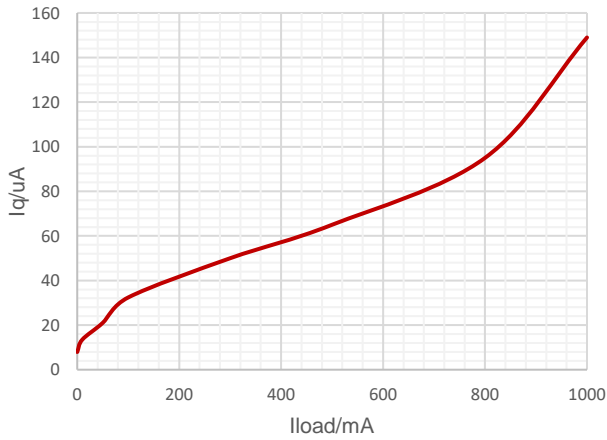

Figure 1. Quiescent Current vs Output Current

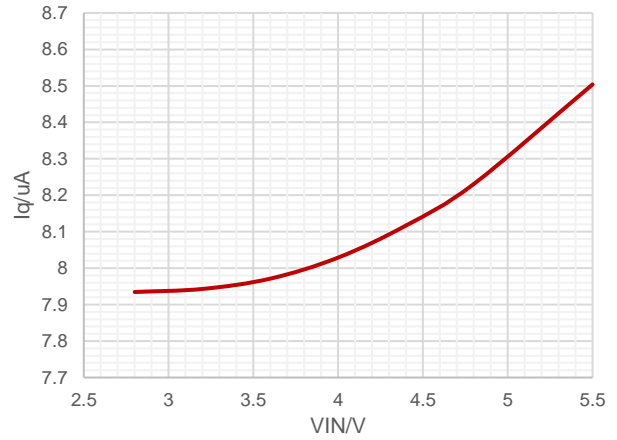

Figure 2. Quiescent Current vs Input Voltage, No load

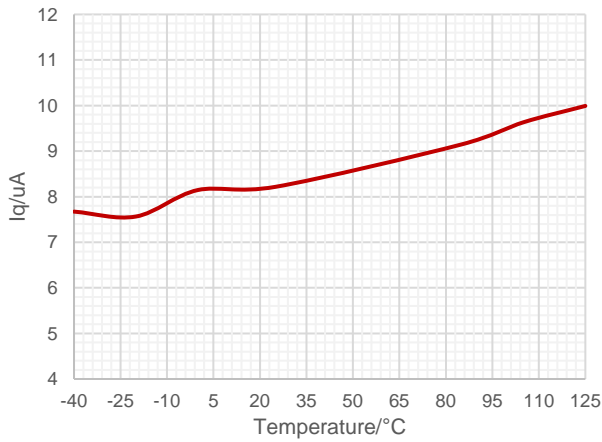

Figure 3. Quiescent Current vs Ambient Temperature

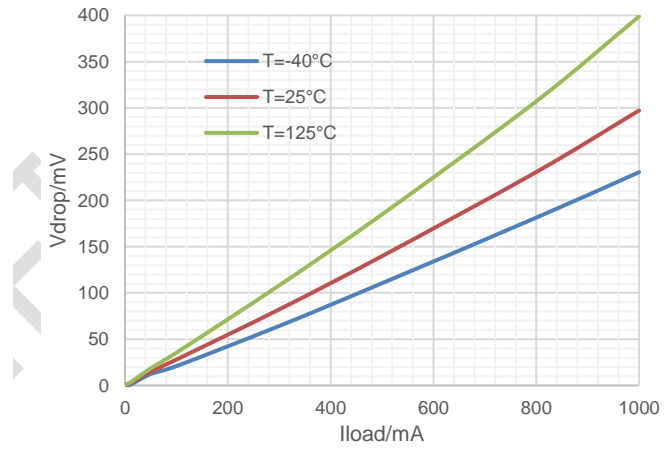

Figure 4. Dropout Voltage vs Output Current

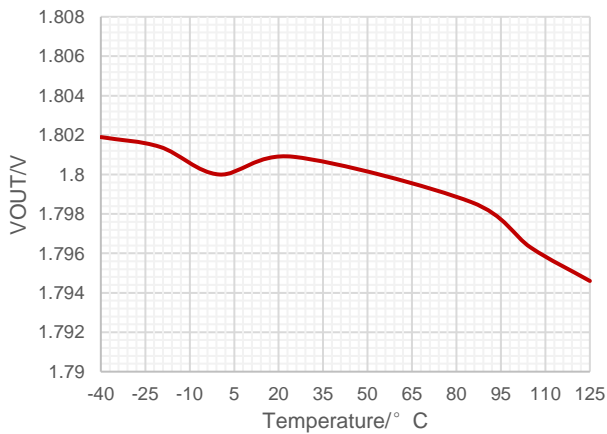

Figure 5. Output Voltage vs Ambient Temperature at VOUT=1.8V

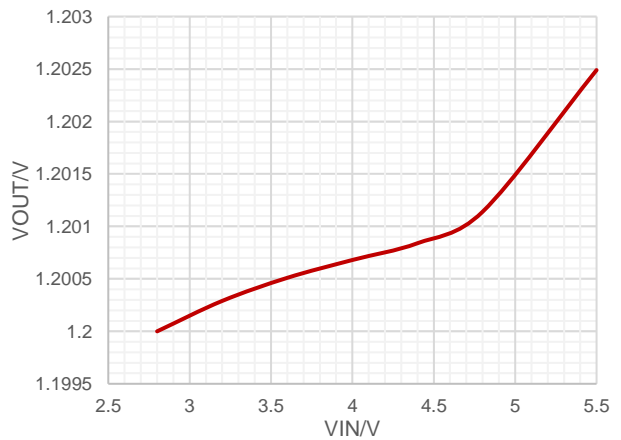

Figure 6. Output Voltage vs Input Voltage

TYPICAL CHARACTERISTICS (continued)

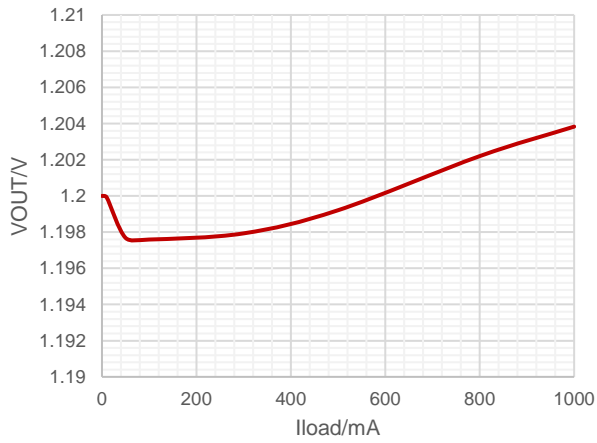

Figure 7. Output Voltage vs Output Current

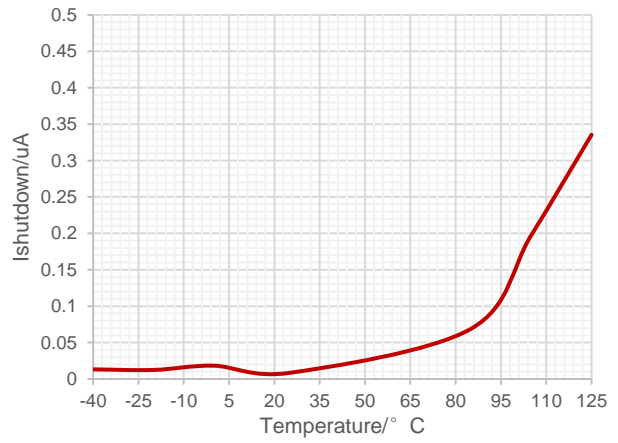

Figure 8. Shutdown Current vs Ambient Temperature

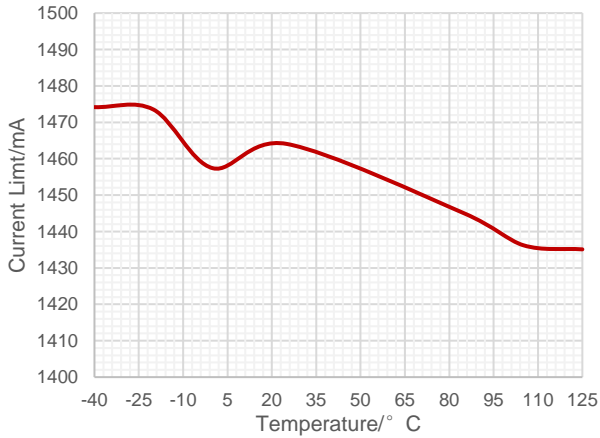

Figure 9. Output Current Limit vs Ambient Temperature

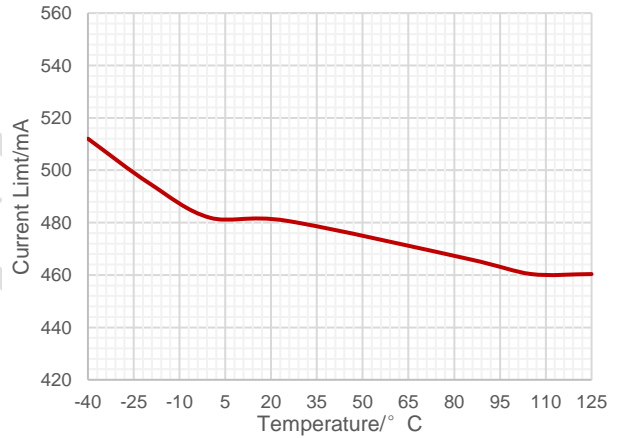

Figure 10. Short Current Limit vs Ambient Temperature

TYPICAL CHARACTERISTICS (continued)

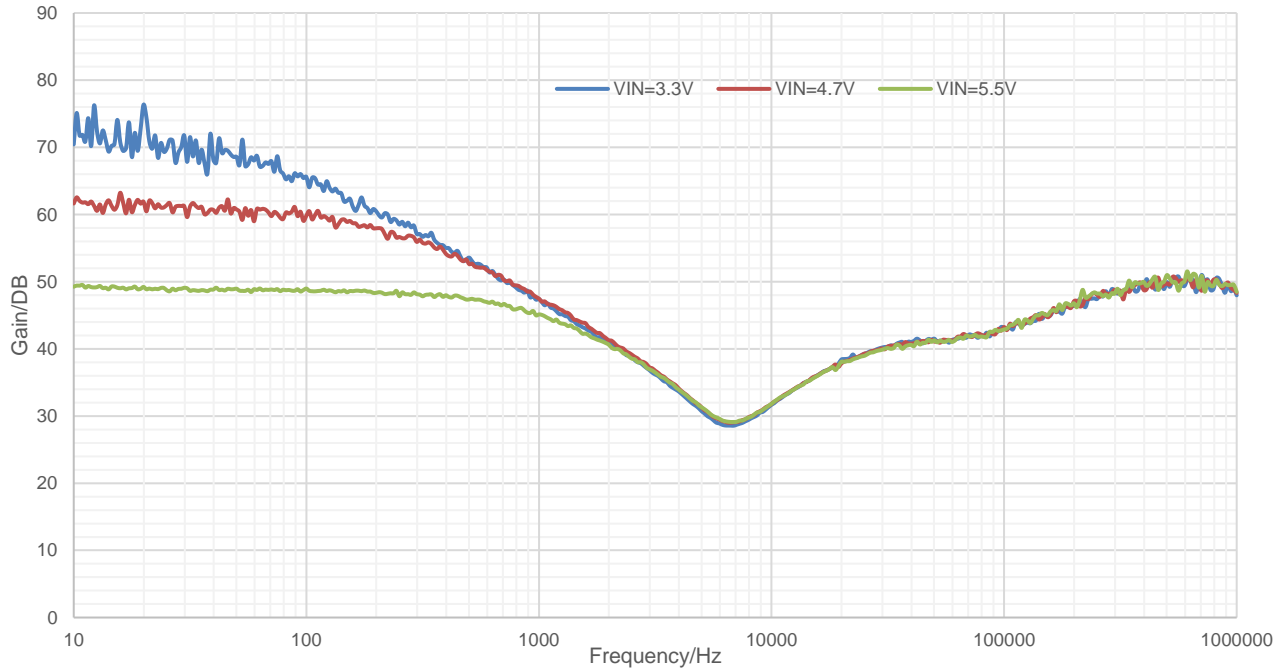

Figure 11. PSRR vs Frequency
VIN=3.3V, VOUT=1.2V, Cf=33pF, COUT=10uF

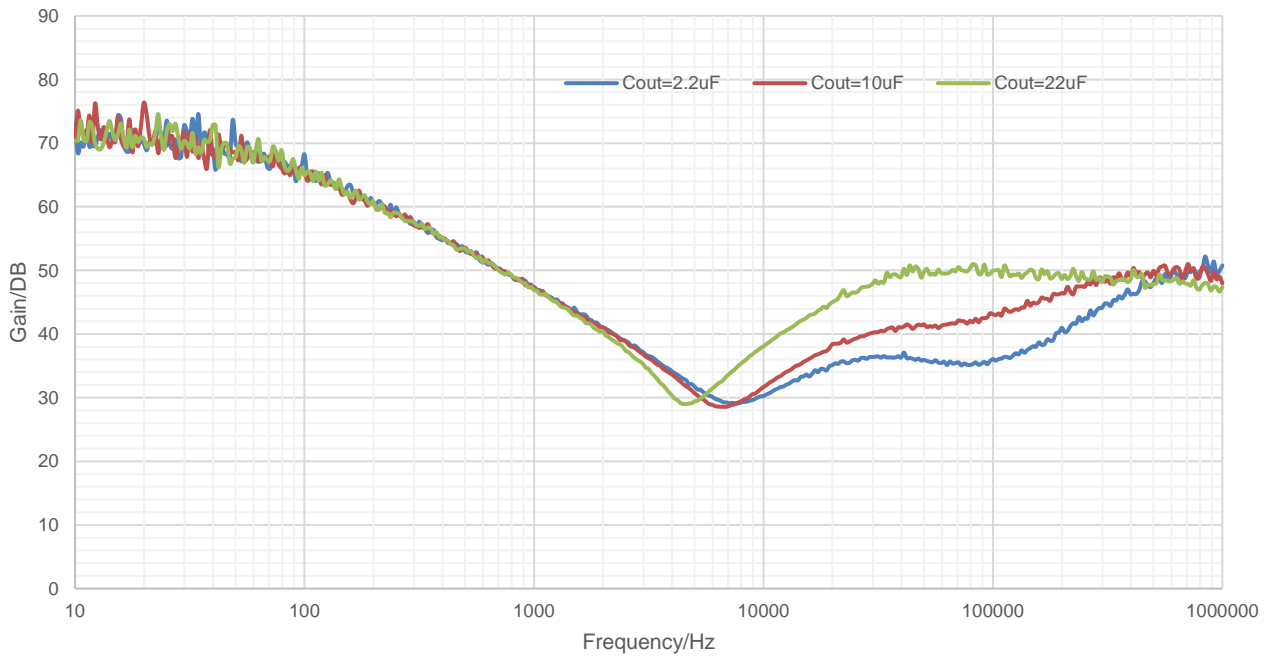

Figure 12. PSRR vs Frequency
VIN=3.3V, VOUT=1.2V, Cf=33pF, IOUT=10mA

SCT71010A00Q Series

TYPICAL CHARACTERISTICS (continued)

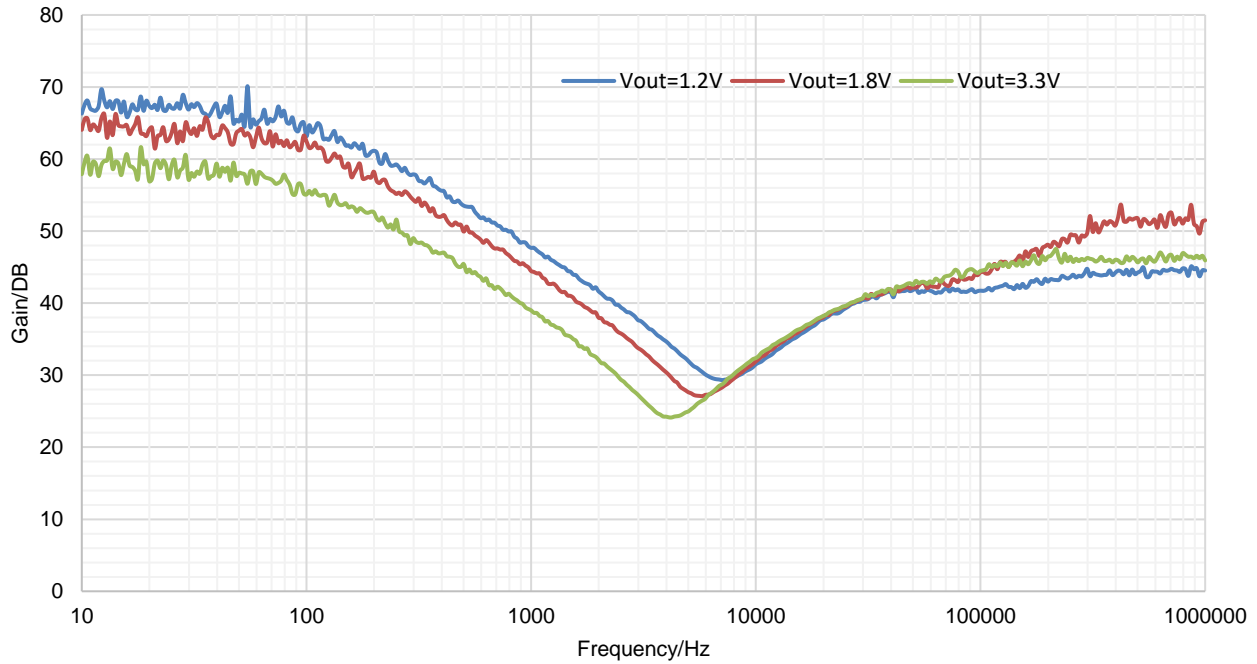

Figure 13. PSRR vs Frequency
VIN=4.3V, Cf=33pF, COU=10uF, IOU=10mA

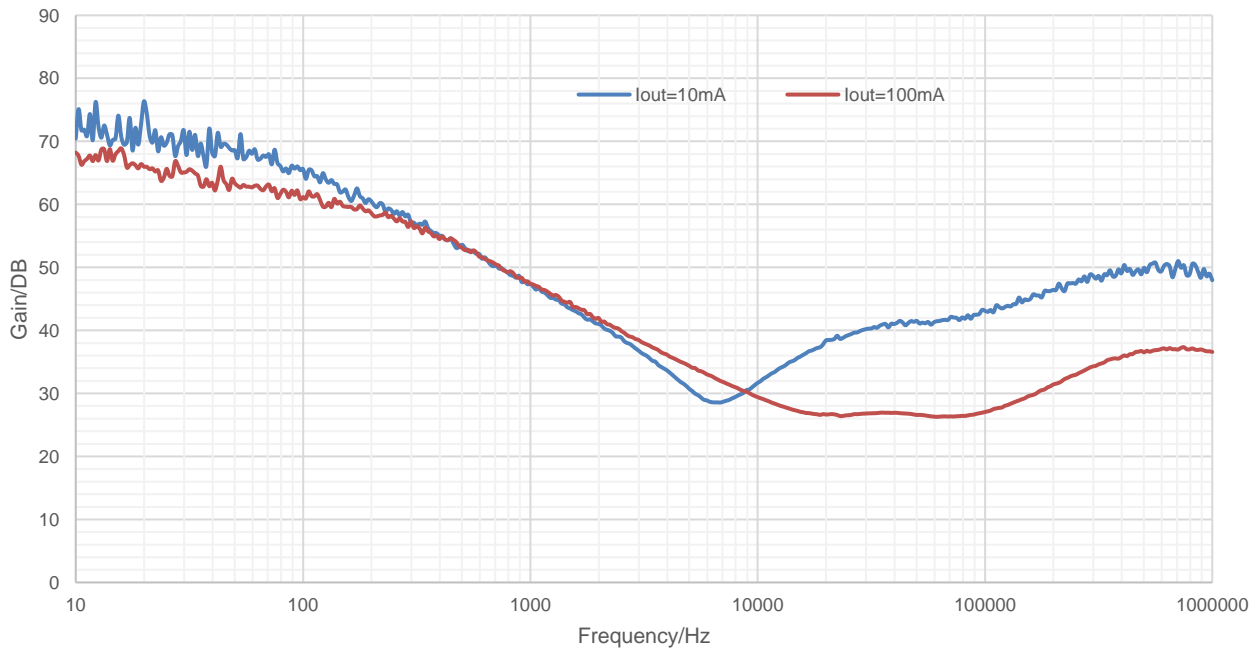

Figure 14. PSRR vs Frequency
VIN=3.3V, VOUT=1.2V, Cf=33pF, COU=10uF

FUNCTIONAL BLOCK DIAGRAM

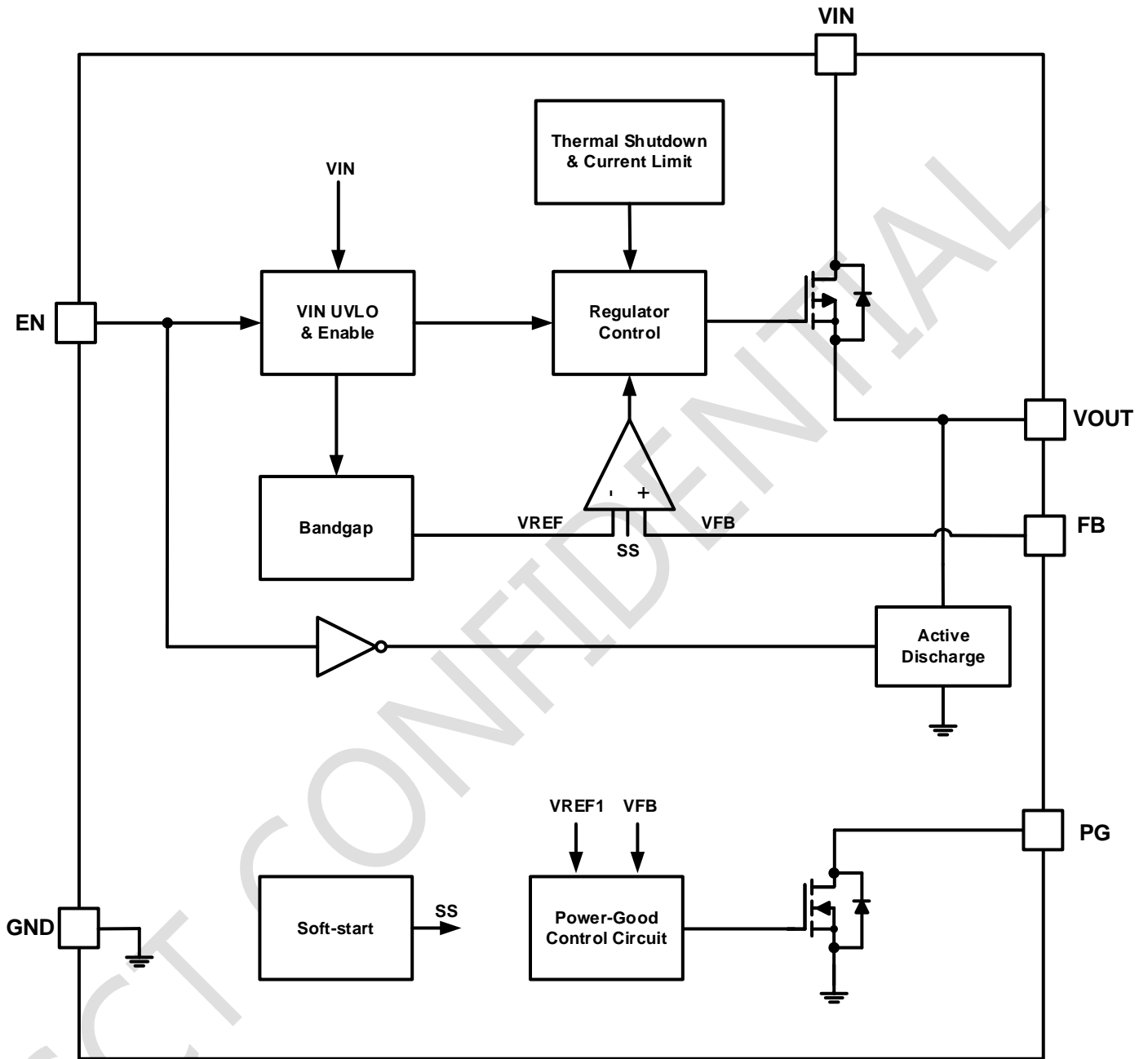

Figure 15. Functional Block Diagram of Adjust Output Version

SCT71010A00Q Series

OPERATION

Overview

The SCT71010A00Q product are 1A output current linear regulators with very low quiescent current. These voltage regulators operate from 2.2V to 5.5V DC input voltage with supporting 6V transient input voltage and consume 8 μ A quiescent current at no load.

The SCT71010A00Q products are stable with 2.2 μ F~220 μ F output capacitors, and 10 μ F ceramic capacitor is recommended. An internal 2.4ms soft-start time avoids large inrush current and output voltage overshoot during startup.

The SCT71010A00Q products also provide enable control which is very suitable for the applications needing sequence configuration. Other protection features include the VIN input under-voltage lockout, over current protection, output hard short protection with OCFB and thermal shutdown protection.

The SCT71010A00Q products are available in adjustable voltage from 0.8V to 5V with 1% output voltage accuracy at room temp and 2% output voltage accuracy over-full temperature range. The product is available in TDFN3x3-8 packages.

If you need a new output voltage version or a new package option, please feel free to contact SCT sales.

Output Enable

The enable pin (EN) is active high. Enable the device by forcing the voltage of the enable pin to exceed the minimum EN pin high-level input voltage. Turn off the device by forcing the voltage of the enable pin to drop below the maximum EN pin low-level input voltage. If shutdown capability is not required, connect EN to IN.

This EN circuit has an pulldown resistor($R_{EN_pulldown}$) disconnected to reduce input current when the output is enabled, and connected when EN pin low to disable the output. Floating the EN pin is not suggestion.

Regulated Output Voltage

The SCT71010A00Q product provide adjustable output which can adjust the output voltage from 0.8V to 5V. When the input voltage is higher than $V_{OUT(NOM)}+V_{DROP}$, output pin is the regulated output based on the selected voltage version. When the input voltage falls below $V_{OUT(NOM)}+V_{DROP}$, output pin tracks the input voltage minus the dropout voltage based on the load current. When the input voltage drops below UVLO threshold, the output keeps shut off.

If you need a new output voltage version or a new package option, please feel free to contact SCT sales.

Output Discharge

The SCT71010A00Q product has an internal pulldown MOSFET that connects an $R_{PULLDOWN}$ resistor to ground when the device is disabled to actively discharge the output voltage. The active discharge circuit is activated by the enable pin.

Do not rely on the active discharge circuit to discharge the output voltage after the input supply has collapsed because reverse current can possibly flow from the output to the input. This reverse current flow can cause damage to the device, especially when a large output capacitor is used. Limit reverse current to no more than 5% of the device rated current for a short period of time.

Over Current Limit and Foldback Current Limit

The SCT71010A00Q product has an internal current limit circuit that protects the regulator during transient high-load current faults or shorting events. The current limit is a hybrid brick-wall foldback scheme. The current limit transitions from a brick-wall scheme to a foldback scheme at the foldback voltage ($V_{FOLDBACK}$). In a high-load current fault with the output voltage above $V_{FOLDBACK}$, the brick-wall scheme limits the output current to the current limit (I_{OC}). When the output voltage drops below $V_{FOLDBACK}$, a foldback current limit activates that scales back the current limit. When the output is shorted, the device supplies a typical current called the short-circuit current limit (I_{SC}). I_{OC} and I_{SC} are listed in the Electrical Characteristics table.

The output voltage is not regulated when the device is in current limit. When a current limit event occurs, the regulator begins to heat up because of the increase in power dissipation. When the device is in brick-wall current limit, the pass transistor dissipates power $[(V_{IN}-V_{OUT}) \times I_{OC}]$. When the output is shorted and the output voltage is less than $V_{FOLDBACK}$, the pass transistor dissipates power $[(V_{IN}-V_{OUT}) \times I_{SC}]$. If thermal shutdown is triggered, the device turns off. After the device cools down, the internal thermal shutdown circuit turns the device back on. If the output current fault condition persists, the device cycles between current limit and thermal shutdown.

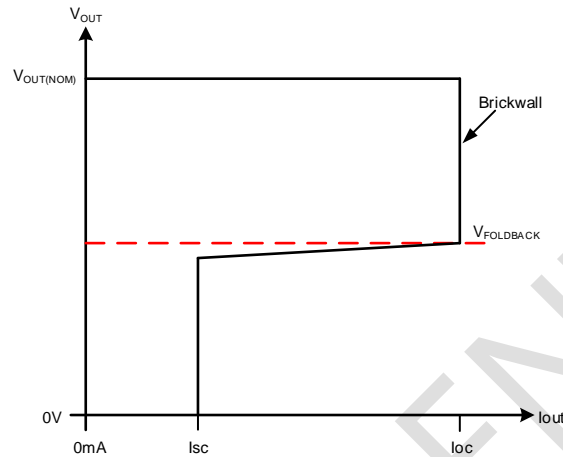

Figure 16. Current Limit with Foldback Feature

Internal Soft-Start

The SCT71010A00Q product integrates an internal soft-start circuit that ramps the reference voltage from zero volts to 0.8V reference voltage in 2.4ms. If the EN pin is pulled below 0.66V, LDO will be shut off and the internal soft-start resets. The soft-start also resets during shutdown due to thermal overloading.

Below figure shows the startup waveform at small output capacitor and large output capacitor. When output capacitor is small, for example 10uF, the slope of V_{OUT} is limit by soft-start. When output capacitor is large, for example 100uF, the slope of V_{OUT} is limited by foldback current limit (I_{SC}) at V_{OUT} < V_{FOLDBACK}, and the slope of V_{OUT} is limited by over current limit (I_{OC}), when V_{OUT} > V_{FOLDBACK}.

In SCT71010A00Q product, typical T_{SS} is 2.4ms, and typical I_{OC} is 1450mA and typical I_{SC} is 480mA, could use the following formula for initial startup time calculation.

$$T_{start} = \max \left\{ \frac{C_{OUT} \times 0.9 \times V_{OUT}}{(I_{SC} - I_{load})} + \frac{C_{OUT} \times 0.9 \times V_{OUT}}{(I_{OC} - I_{load})}, T_{SS} \right\} \quad (1)$$

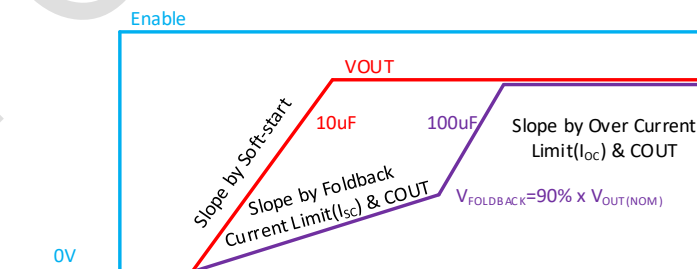

Figure 17. Soft-start Waveform vs Output Capacitor

Power-Good and Power-Good Delay

SCT71010A00Q Series

The power-good (PG) pin is an open-drain output and can be connected to any 5V or lower rail through an external pull-up resistor. The PG output is high-impedance when V_{OUT} is greater than the PG trip threshold ($V_{PG_R}=88\% \times V_{OUT(NOM)}$). If V_{OUT} drops below $V_{PG_F}=82\% \times V_{OUT(NOM)}$, the open-drain output turns on and pulls the PG output low. If output voltage monitoring is not needed, the PG pin can be left floating or connected to GND.

The power-good delay time (T_{d_PGR}) is defined as the time period from when V_{OUT} exceeds the PG trip threshold voltage (V_{PG_R}) to when the PG output is high. This power-good delay time is set by an internal time, which is 170us typical. The power-good deglitch time (T_{d_PGF}) is defined as the time period from when V_{OUT} fall below the PG trip threshold voltage (V_{PG_F}) to when the PG output is low. This power-good deglitch time is set by an internal time, which is 88us typical. If the power-good delay time is not enough for some application, could try to connect a capacitor from PG pin to GND and using PG pull-up resistor and this capacitor generate extra delay time to meet your design.

To ensure proper operation of the power-good feature, maintain $V_{IN} \geq 2.2V$ (V_{IN_MIN}). It allows connections of PG pin to circuit with the same or different power supply voltage to the LDO's V_{OUT} level. Below are the connections examples.

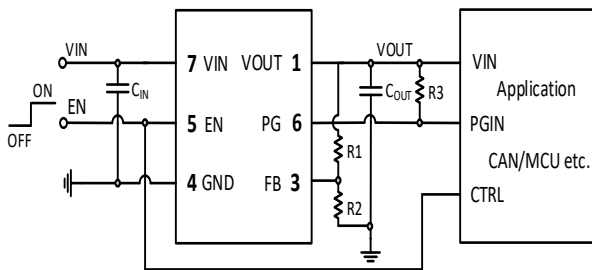

Figure 18. PG Connected to LDO's Output

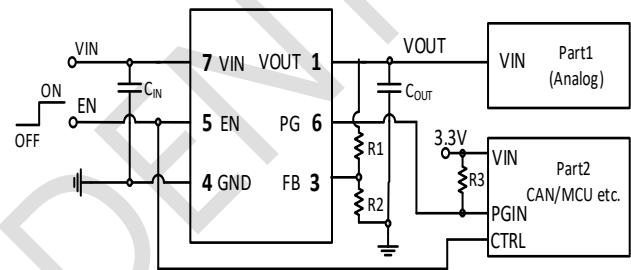

Figure 19. PG Connected to the other Power Supply

Below figure shows the startup and shutdown situation when slow power up and power down.

At the point 0, the input voltage starts to rise from 0 to 5V, LDO is in shutdown (because V_{IN} is below its UVLO threshold) and output voltage is 0V.

At the point 1, the V_{IN} voltage reaches UVLO threshold level and LDO starts charging of output capacitor. V_{OUT} rising speed is defined by internal soft-start function.

At the point 2, the V_{OUT} voltage reaches almost the V_{IN} voltage as it rises faster and LDO gets into dropout region. The difference between V_{IN} and V_{OUT} is the dropout voltage.

At the point 3, the V_{OUT} reaches PG threshold ($V_{PG_R}=88\% \times V_{OUT(NOM)}$) and from this point LDO counts the power good delay time (T_{d_PGR}). After this delay, the PG pin rises to high level showing that V_{OUT} is ok.

At the point 4, the V_{OUT} reaches its nominal value (3.3V) as the V_{IN} starts to be higher than ($V_{OUT(NOM)} + V_{DROP}$) and LDO gets into regulation region.

At the point 5, as the V_{IN} voltage slow power down and LDO returns to dropout region again.

At the point 6, the V_{OUT} drops below PG threshold ($V_{PG_F}=82\% \times V_{OUT(NOM)}$) and LDO starts counting the power good deglitch time (T_{d_PGF}), which filters fast V_{OUT} undershoots (caused for example by line/load transient responses). After this delay, the PG output is shorted to 0 V level to highlight "power fail" state.

At the point 7, the V_{IN} voltage is lower than input voltage UVLO threshold minus UVLO hysteresis level and LDO goes into the shutdown state.

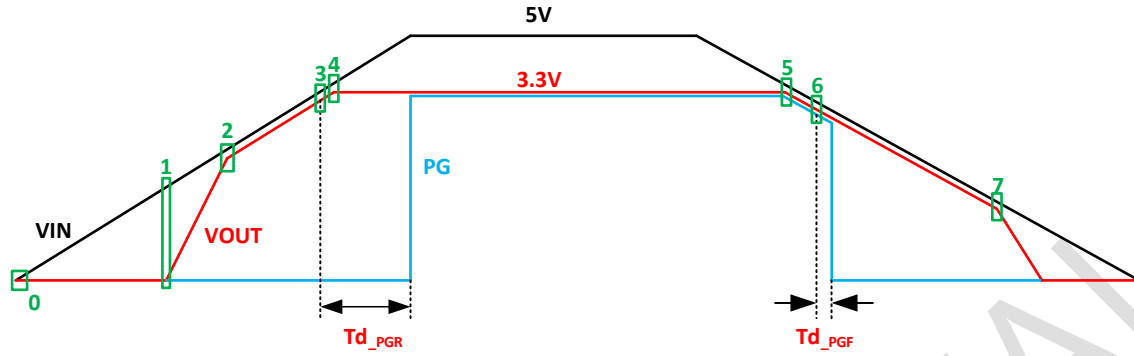

Figure 20. Startup and Shutdown Example —SCT71010Q Series

Thermal Shutdown

This device incorporates a thermal shutdown (T_{SD}) circuit as a protection from overheating. For continuous normal operation, the junction temperature should not exceed the T_{SD} trip point. The junction temperature exceeding the T_{SD} trip point causes the output to turn off. When the junction temperature falls below the T_{SD} trip point minus thermal shutdown hysteresis, the output turns on again.

SCT71010A00Q Series

APPLICATION INFORMATION

Typical application 1:

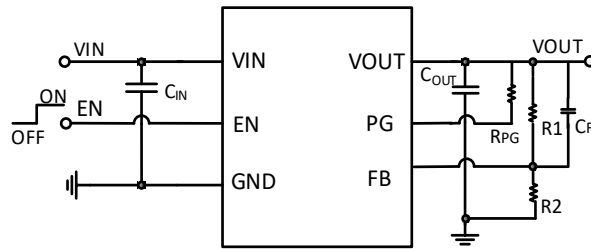

Figure 21. SCT71010A00Q Typical Application Schematic

Design Parameters

Design Parameters	Example Value
Input Voltage	5V Normal, 2.2V~5.5V
Output Voltage	0.8V~5V
Maximum Output Current	1A
Output Capacitor Range (C_{OUT})	2.2 μ F~22 μ F , recommends 10 μ F
Input Capacitor Range (C_{IN})	>2.2 μ F , recommends 10 μ F

Typical application 2:

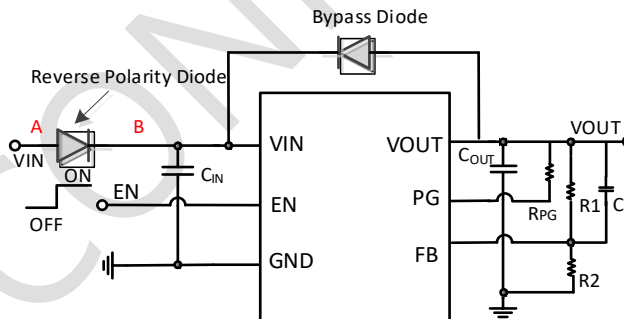

Figure 22. SCT71010A00Q Typical Application Schematic with Reverse Polarity Diode

Design Parameters

Design Parameters	Example Value
Input Voltage	5V Normal, 2.2V~5.5V
Output Voltage	0.8V~5V
Maximum Output Current	1A
Output Capacitor Range (C_{OUT})	2.2 μ F~22 μ F , recommends 10 μ F
Input Capacitor Range (C_{IN})	>2.2 μ F , recommends 10 μ F

In some applications, the VIN and the VOUT potential might be reversed, possibly resulting in circuit internal damage or damage to the elements. For example, the accumulated charge in the output pin capacitor flowing

backward from the VOUT to the VIN when the VIN shorts to the GND. In order to minimize the damage in such case, use a capacitor with a capacitance less than 220 μ F. Also by inserting a reverse polarity diode in to the VIN, it can prevent reverse current from reverse battery connection or the case, when the point A is short-circuited GND. If there may be any possible case point B is short-circuited to GND, we also recommend using a bypass diode between the VIN and the VOUT.

Typical application 3:

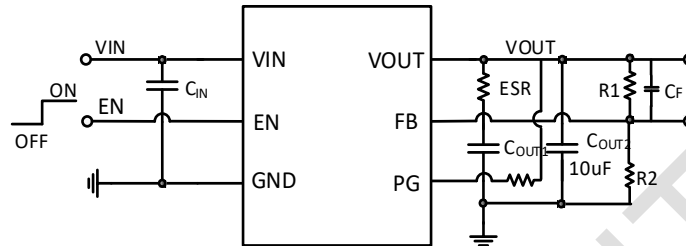

Figure 23. SCT71010A00Q Typical Application Schematic with Large Output Capacitor

Design Parameters

Design Parameters	Example Value
Input Voltage	5V Normal, 2.2V~5.5V
Output Voltage	0.8V~5V
Maximum Output Current	1A
Output Capacitor Range (C_{OUT1} and ESR)	2.2 μ F~220 μ F with ESR=0.5 Ω ~5 Ω
Output Capacitor Range (C_{OUT2})	recommends 10 μ F with low ESR
Input Capacitor Range (C_{IN})	>2.2 μ F , recommends 10 μ F

SCT71010A00Q Series

Output Voltage

The output voltage is set by an external resistor divider R1 and R2 in typical application schematic. Recommended R2 resistance is 100kΩ. Use equation 2 to calculate R1.

$$R_1 = \left(\frac{V_{OUT}}{V_{REF}} - 1 \right) * R_2 \quad (2)$$

where:

- V_{REF} is the feedback reference voltage, typical 800mV

Table 1: Compensation Values for Typical Output Voltage/Capacitor Combinations

Vout/V	COU1/uF	Cf/pF	R1/kΩ	R2/kΩ	COU1/uF (optional)	ESR/Ω
1.2	10	33	49.9	100	220	1
1.8	10	33	124	100	220	1
2.4	10	33	200	100	220	1
3.3	10	33	309	100	220	1
5	10	33	523	100	220	1

Input Capacitor and Output Capacitor

SCT recommends adding a 2.2μF or greater capacitor with a 0.1μF bypass capacitor in parallel at VIN pin to keep the input voltage stable. Aluminum electrolytic capacitor or other capacitor with high capacitance is suggested for the system power with large voltage spike. The voltage rating of the capacitors must be greater than the maximum input voltage

To ensure loop stability, the SCT71010A00Q product requires an output capacitor with a minimum effective capacitance value of 2.2μF. And the product could support output capacitor range from 2.2uF to 220uF and with an ESR range between 0.001Ω and 5Ω. SCT recommends selecting a X5R- or X7R-type 4.7uF~10uF ceramic capacitor with low ESR over temperature range to improve the load transient response.

To further improve loop stability, we recommend using feed forward capacitors. The specific values can refer to the Figure24 and Figure25.

When using large output capacitor with higher ESR resistor, for example 100uF output electrolytic capacitor with 1Ω ESR resistor in the application, SCT recommends adding extra 10uF low ESR output capacitor parallel connection with the large electrolytic capacitor, this will eliminate the undershoot/overshoot voltage caused by the large ESR resistor and get better load transient performance.

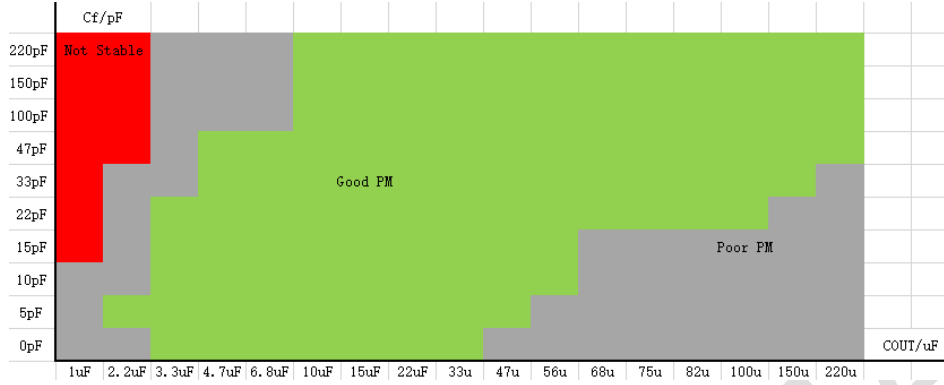

Figure 24. SCT71010A00Q Feed Forward Capacitors recommend(R2=100kΩ,VOUT=1.8V)

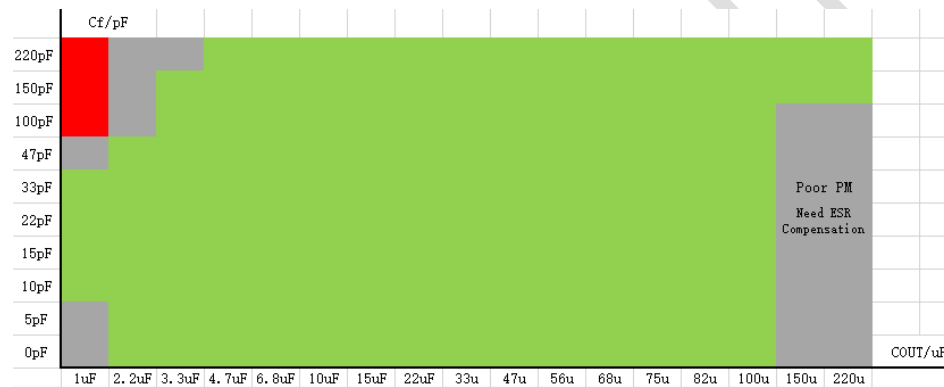

Figure 25. SCT71010A00Q Feed Forward Capacitors recommend(R2=10kΩ,VOUT=1.8V)

SCT71010A00Q Series

Power Dissipation and Thermal Performance

Power dissipation caused by voltage drop across the LDO and by the output current flowing through the device needs to be dissipated out from the chip. The maximum junction temperature is dependent on power dissipation, package, the PCB layout, number of used Cu layers, Cu layers thickness and the ambient temperature.

During normal operation, LDO junction temperature should not exceed 150°C, or else it may result in deterioration of the properties of the chip. Using below equations to calculate the power dissipation and estimate the junction temperature.

The power dissipation can be calculated using Equation 3. Because $I_{GND} \ll I_{OUT}$, the term $V_{IN} \times I_{GND}$ in Equation 3 could be ignored.

$$P_D = (V_{IN} - V_{OUT}) \times I_{OUT} + V_{IN} \times I_{GND} \quad (3)$$

The junction temperature can be estimated using Equation 4. $R_{\theta JA_EVM}$ is the junction-to-ambient thermal resistance based on customer's PCB. Verify the application and allow sufficient margins in the thermal design by the following method is used to calculate the junction temperature T_J .

$$T_J = T_A + P_D \times R_{\theta JA_EVM} \quad (4)$$

$R_{\theta JA_EVM}$ is a critical parameter and depends on many factors such as the following:

- Power dissipation
- Air temperature/flow
- PCB area
- Copper heat-sink area
- Number of thermal vias under the package
- Adjacent component placement

For the SCT71010A00Q product, the maximum allowable power dissipation of different packages was listed in the following table, and the test results are based on our EVM board, larger power dissipation will trigger thermal shutdown protection. As a result, we could calculate the $R_{\theta JA_EVM}$ of different packages. The following table is just for your reference based on our EVM test, please leave enough margin when you design thermal performance.

The PCB information of our EVM: 4-layer, 1oz Cu (inner 0.5oz Cu), 50mm x 30mm size.

Thermal Performance of Different Packages Based on EVM Test

Package	Max Allowable PD (W) (Not Trigger TSD, VOUT=5V)	Max Allowable PD (W) (T _J ≤150°C)	R _{θJA_EVM} (°C/W)
TDFN3X3-8	2.73	2.35	53.09

THERMAL CHARACTERISTICS

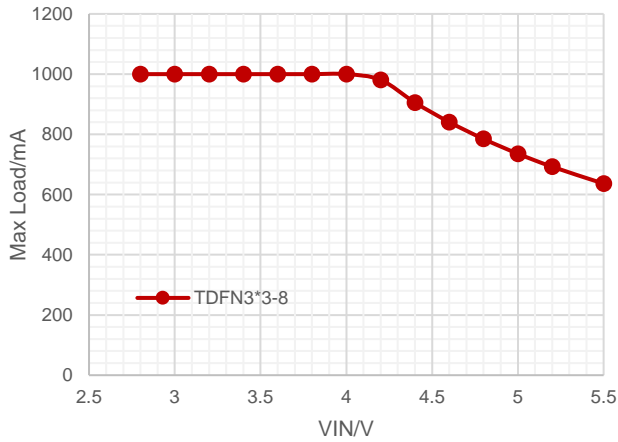

Figure 26. Maximum Output Current vs Input Voltage, VOUT=5V of TDFN3X3, $T_J \leq T_{SD_R}$

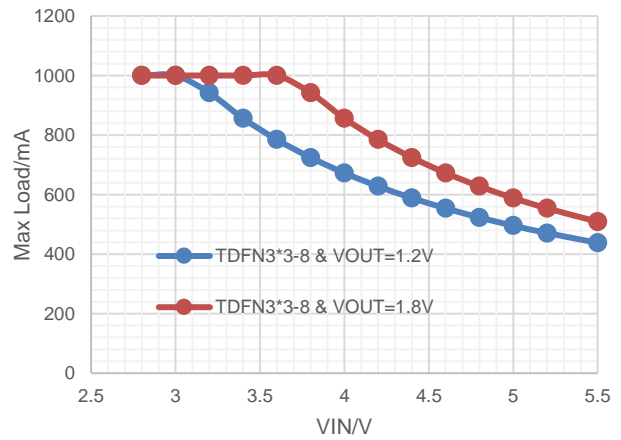

Figure 27. Maximum Output Current vs Input Voltage, TDFN3X3, $T_J \leq 125^\circ\text{C}$

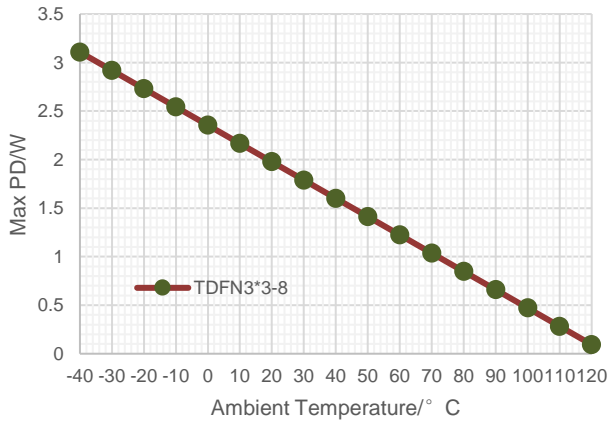

Figure 28. Maximum Allowed Power Dissipation vs Ambient Temperature, TDFN3X3, $T_J \leq 125^\circ\text{C}$

SCT71010A00Q Series

Application Waveforms

$V_{in} = V_{out} + 1V$, unless otherwise noted

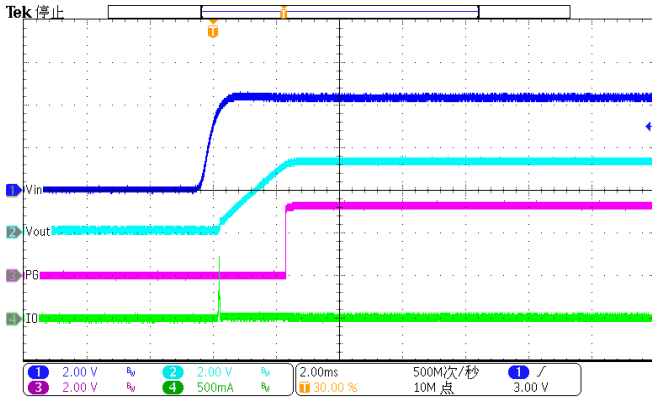

Figure 29. Power up (Iload=10mA)

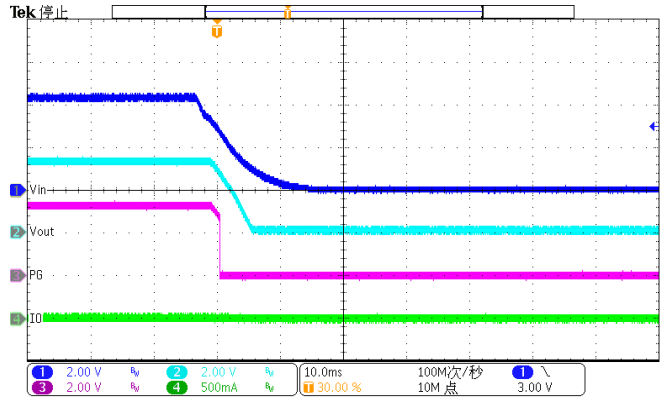

Figure 30. Power down (Iload=10mA)

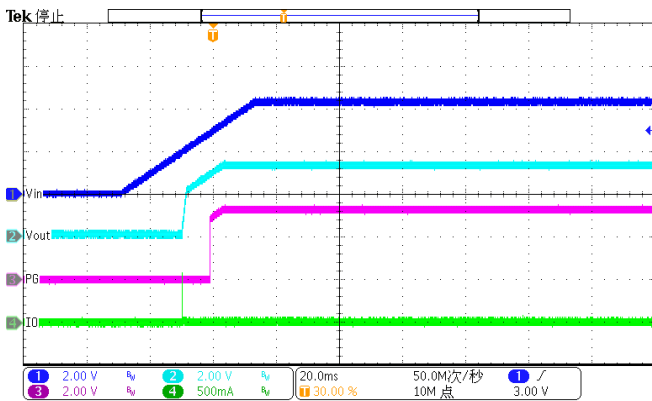

Figure 31. Slow Power up (Iload=10mA)

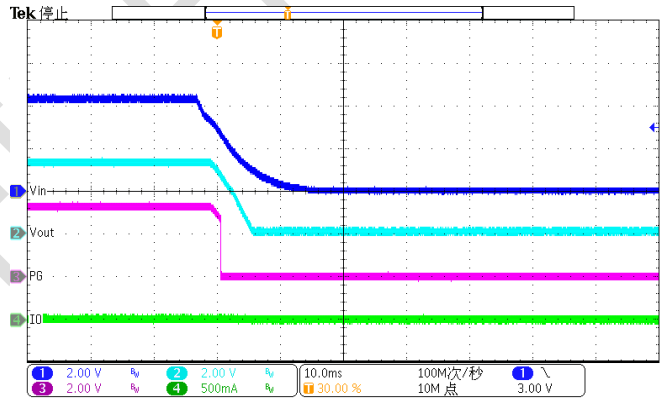

Figure 32. Slow Power down (Iload=10mA)

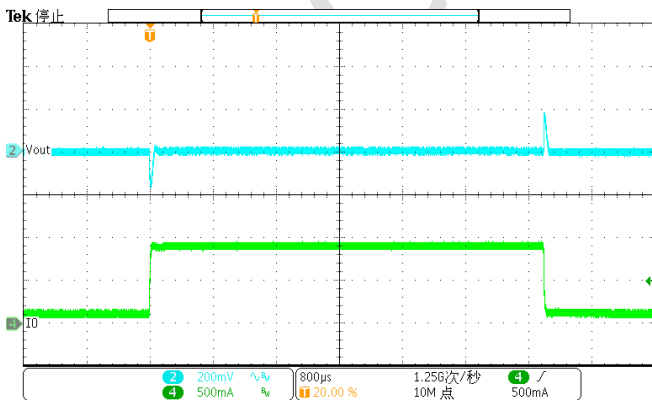

Figure 33. DC-DC Load Transient
(100mA-900mA), $V_{OUT} = 3.3V$

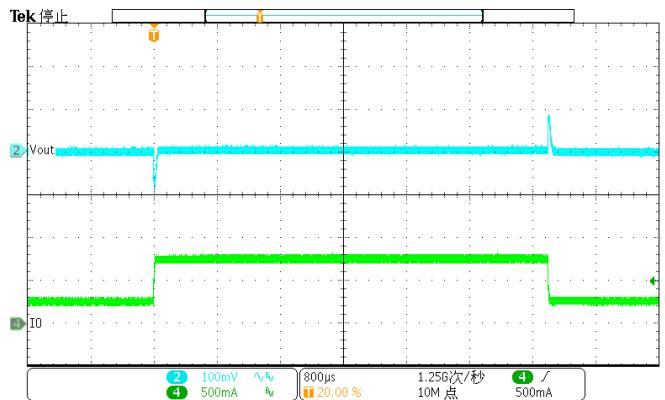

Figure 34. DC-DC Load Transient
(250mA-750mA), $V_{OUT} = 3.3V$

Application Waveforms(Continued)

Vin=Vout +1V, unless otherwise noted

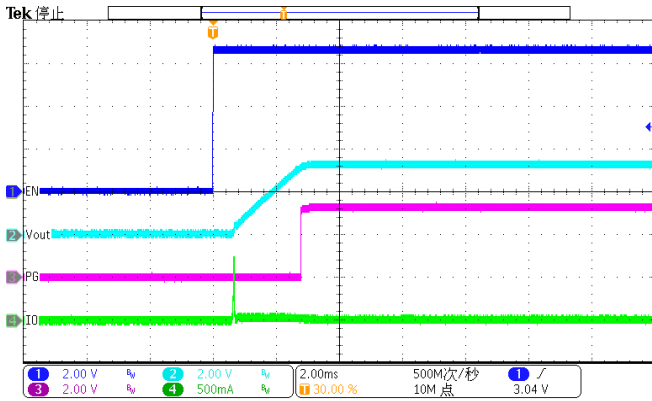

Figure 35. Enable (Iload=10mA)

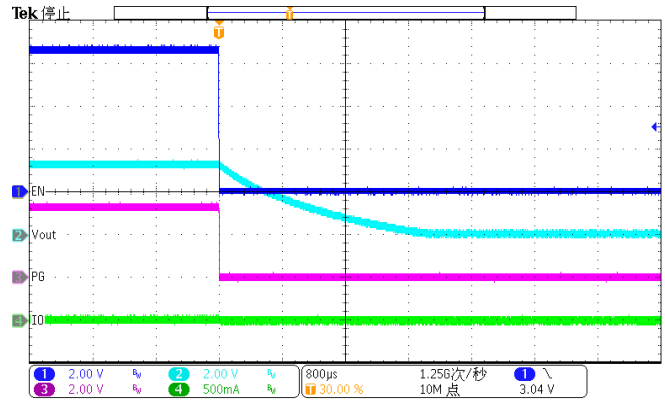

Figure 36. Disable (Iload=10mA)

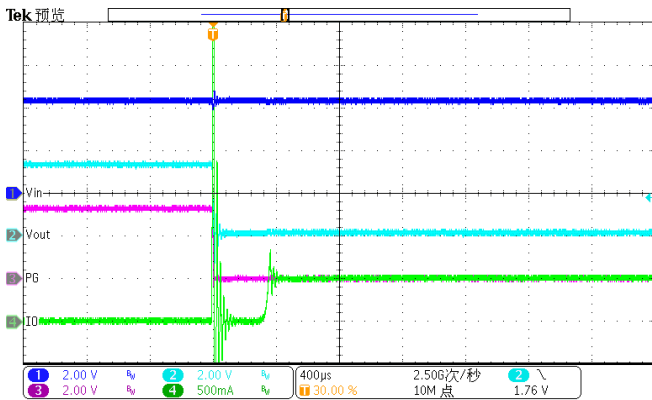

Figure 37. Enter Short Circuit Protection

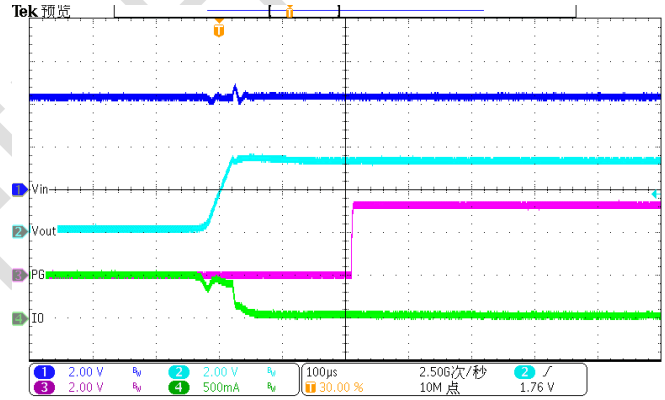

Figure 38. Exit Short Circuit Protection

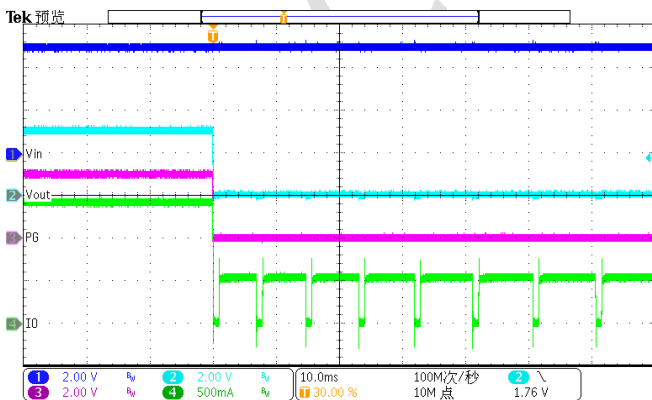

Figure 39. Enter Over Temperature Protection(Vin=5.5V)

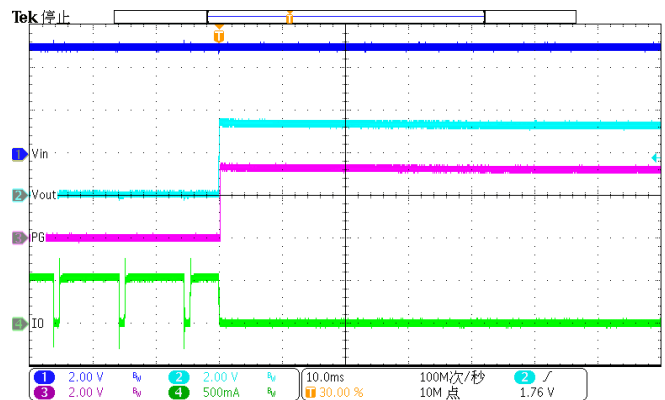

Figure 40. Exit Over Temperature Protection(Vin=5.5V)

SCT71010A00Q Series

Layout Guideline

Proper PCB layout is a critical for SCT71010Q's stability, transient performance and good regulation characteristics. For better results, follow these guidelines as below:

1. Both input capacitors and output capacitors must be placed as close to the device pins as possible.
2. It is recommended to bypass the input pin to ground with a 0.1 μ F bypass capacitor. The loop area formed by the bypass capacitor connection, V_{IN} pin and the GND pin of the system must be as small as possible.
3. It is recommended to use wide trace lengths or thick copper weight to minimize $I \times R$ drop and heat dissipation.
4. To improve the thermal performance of the device, and maximize the current output at high ambient temperature, SCT recommends spreading the copper under the thermal pad as far as possible and placing enough thermal vias on the copper under the thermal pad.
5. If using large electrolytic capacitor with high ESR resistor, SCT recommends adding a 10 μ F low ESR capacitor parallel connection with the large electrolytic capacitor.

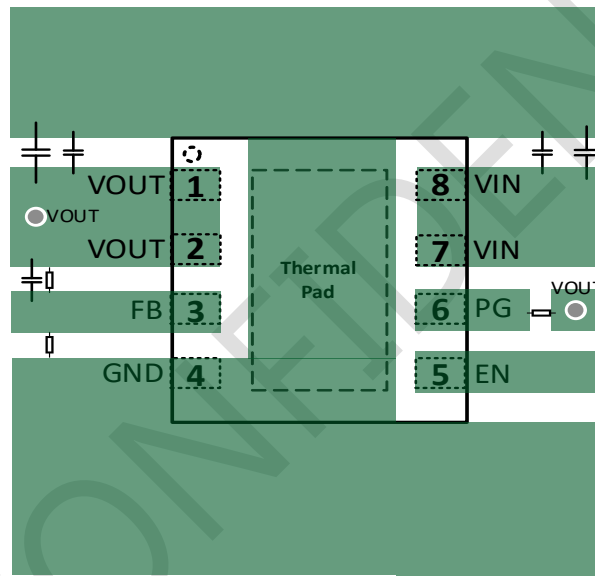
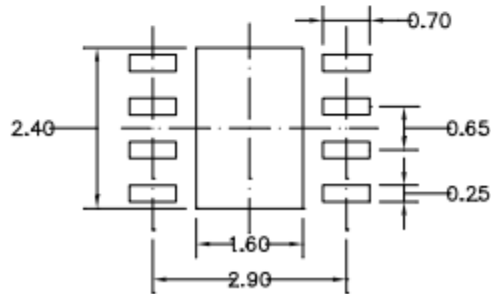
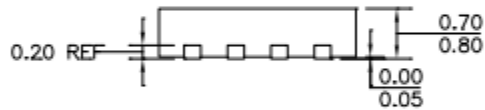
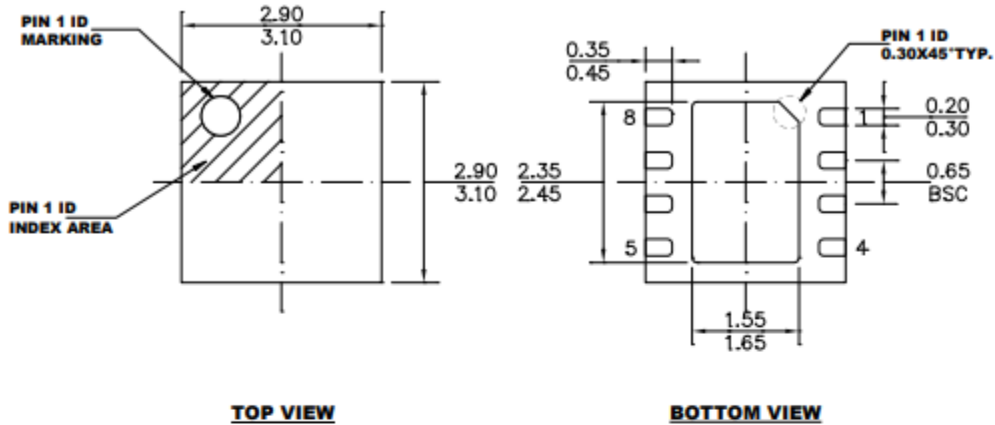

Figure 41. PCB Layout Example

SCT71010A00QDTBR

PACKAGE INFORMATION



NOTE:

- 1) ALL DIMENSIONS ARE IN MILLIMETERS.
- 2) EXPOSED PADDLE SIZE DOES NOT INCLUDE MOLD FLASH.
- 3) LEAD COPLANARITY SHALL BE 0.08 MILLIMETERS MAX.
- 4) JEDEC REFERENCE IS MO-220.
- 5) DRAWING IS NOT TO SCALE.

RECOMMENDED LAND PATTERN

TDFN3x3-8 Package Outline Dimensions

NOTE:

1. Drawing proposed to be made a JEDEC package outline MO-220 variation.
2. Drawing not to scale.
3. All linear dimensions are in millimeters.
4. Thermal pad shall be soldered on the board.
5. Dimensions of exposed pad on bottom of package do not include mold flash.
6. Contact PCB board fabrication for minimum solder mask web tolerances between the pins.

SCT71010A00Q Series

TAPE AND REEL INFORMATION

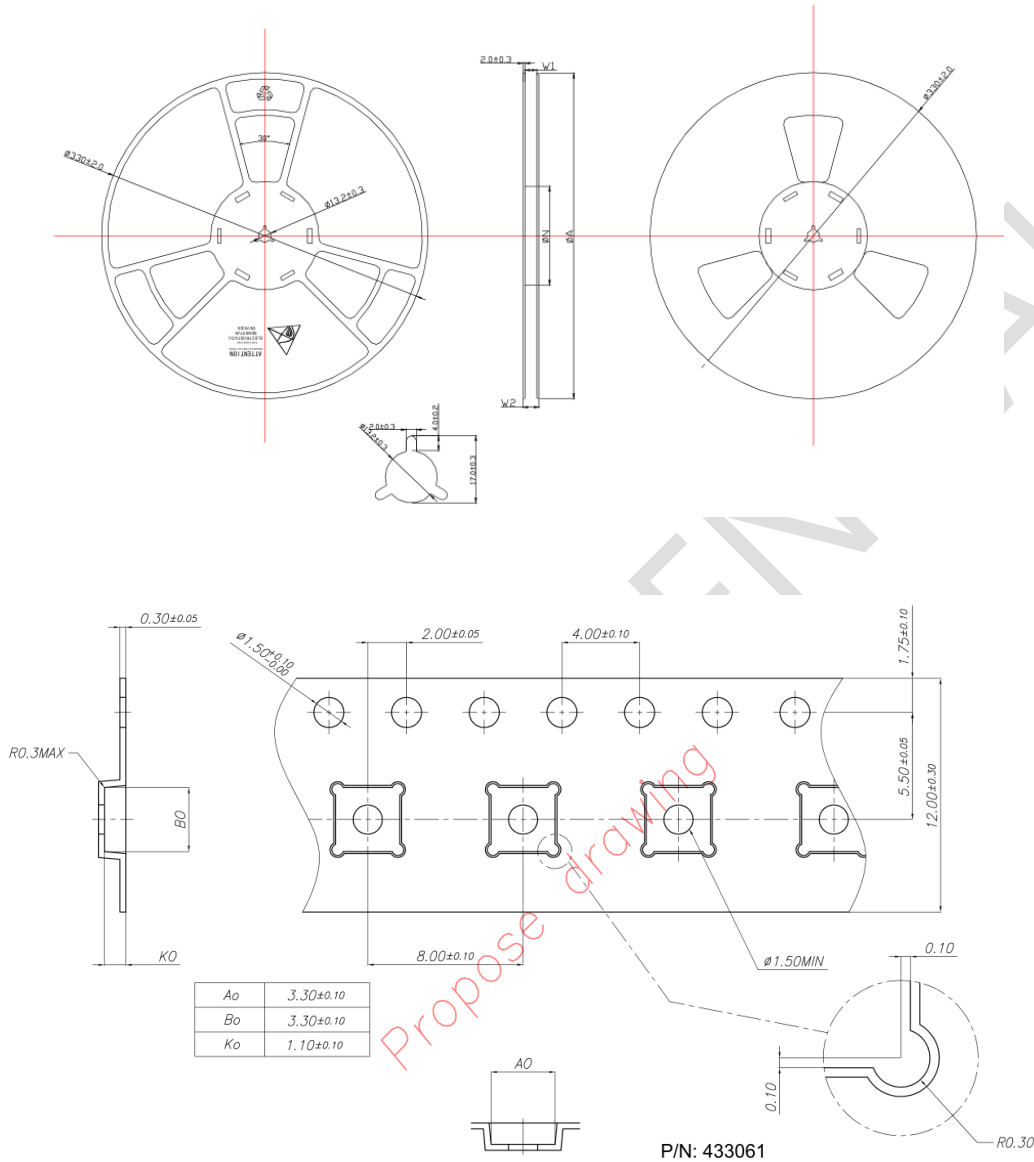

NOTICE: The information in this document is subject to change without notice. Users should warrant and guarantee the third party Intellectual Property rights are not infringed upon when integrating Silicon Content Technology (SCT) products into any application. SCT will not assume any legal responsibility for any said applications.